

# Elfin-EW1X

## RS232/RS485 to Wi-Fi

### User Manual

V 1.3



## Overview of Characteristic

- ◇ Support 802.11bgn Wireless Standard
- ◇ Support TCP/UDP/Telnet /Modbus TCP Protocol
- ◇ Support RS232/RS485 to Wi-Fi Conversion, Serial Speed Up to 230400 bps
- ◇ Support STA/AP/AP+STA Mode
- ◇ Support SmartLink V8 Smart Config (Provide APP)

- ◇ **Support Easy Configuration Through Web Interface or PC IOTService Tool**
- ◇ **Support Security Protocol Such As TLS/AES/DES3**
- ◇ **Support Webpage OTA Wirelss Upgrade**
- ◇ **Support Internal PCB Antenna**
- ◇ **Wide DC Input**
  - **Elfin-EW10, Elfin-EW11, Elfin-EW10-0, Elfin-EW11-0: 5~18VDC**
  - **Elfin-EW10A-0, Elfin-EW11A-0, Elfin-EW10A-0, Elfin-EW11A-0: 5~36VDC**
- ◇ **Size: 61 x 26 x 17.8 mm (L x W x H)**
- ◇ **FCC/CE/SRRC/IC Certificated**

## TABLE OF CONTENTS TABLE OF CONTENTS

<b>TABLE OF CONTENTS TABLE OF CONTENTS .....</b>	<b>3</b>
<b>LIST OF FIGURES.....</b>	<b>4</b>
<b>LIST OF TABLES .....</b>	<b>5</b>
<b>HISTORY.....</b>	<b>5</b>
<b>1. PRODUCT OVERVIEW.....</b>	<b>6</b>
1.1. General Description.....	6
1.2. Device Parameters.....	6
1.3. Key Application.....	7
<b>2. HARDWARE INTRODUCTION .....</b>	<b>8</b>
2.1. Elfin-EW10 Pins Definition.....	8
2.2. Elfin-EW11 Pins Definition.....	9
2.3. RS232 Interface.....	10
2.4. RS485 Interface.....	10
2.5. Mechanical Size.....	11
2.6. RJ45 8PIN Connector.....	11
2.7. RJ45 4PIN Connector.....	12
2.8. EW10 Interface Conversion Cable.....	14
2.9. EW11 Interface Conversion Cable.....	15
2.10. Fixed Bracket.....	16
2.11. Rail Bracket.....	16
2.12. Bracket.....	16
2.13. Product Installation.....	18
2.14. EVK.....	18
2.15. Order Information.....	19
<b>3. NETWORK STRUCTURE.....</b>	<b>20</b>
<b>3.1. Wireless Network.....</b>	<b>20</b>
3.1.1. AP Network.....	20
3.1.2. STA Wireless Network.....	21
3.1.3. AP+STA Wireless Network.....	21
3.1.4. IOTService Software.....	23
3.1.5. Webpage Configuration.....	23
<b>4. FUNCTION DESCRIPTION.....</b>	<b>25</b>
<b>APPENDIX A: CONTACT INFORMATION .....</b>	<b>26</b>

## LIST OF FIGURES

Figure 1.	Elfin-EW10 Appearance.....	8
Figure 2.	Elfin-EW11 Appearance.....	8
Figure 3.	Elfin-EW10 RJ45 Interface Pin .....	9
Figure 4.	Elfin-EW11 RJ45 Interface Pin .....	9
Figure 5.	Elfin-EW1X Mechanical Dimension .....	11
Figure 6.	RJ45 8PIN Connector .....	11
Figure 7.	EW10 +8PIN Connector .....	12
Figure 8.	EW11+8PIN Connector .....	12
Figure 9.	RJ45 4PIN Connector .....	12
Figure 10.	EW10 +4PIN Connector .....	13
Figure 11.	EW11+4PIN Connector .....	13
Figure 12.	Interface Conversion Cable .....	14
Figure 13.	Cable Manufacture Guide .....	15
Figure 14.	Interface Conversion Cable .....	15
Figure 15.	Fixed Bracket.....	16
Figure 16.	Rail Bracket .....	16
Figure 17.	Bracket Size.....	16
Figure 18.	Bracket Install Picture .....	17
Figure 19.	Product Installation .....	18
Figure 20.	EVK Package.....	19
Figure 21.	Elfin-EW1X Product Order Information .....	19
Figure 22.	General AP Network .....	20
Figure 23.	STA Application .....	21
Figure 24.	AP+STA Wireless Network .....	22
Figure 25.	Configure Wi-Fi Parameter .....	23
Figure 26.	STA Scan Parameter.....	23
Figure 27.	Configure the Wi-Fi Parameter .....	24
Figure 28.	STA Scan.....	24

**LIST OF TABLES**

Table1. Elfin-EW1X Technical Specifications ..... 6

Table2. Elfin-EW10 Interface Definition ..... 9

Table3. Elfin-EW11 Interface Definition ..... 9

**HISTORY**

- Ed. V1.0** 07-04-2018 First Version
- Ed. V1.1** 09-18-2018 Fix LED description. Add more attachment description.
- Ed. V1.2** 04-19-2019 Update baud rate, add accessories and external antenna.

# 1. PRODUCT OVERVIEW

## 1.1. General Description

The Elfin-EW1X provides RS232/RS485 interface to Wi-Fi connectivity. The Elfin-EW1X integrate TCP/IP controller, memory, high-speed serial port and integrates a fully developed TCP/IP network stack and mbed OS. Elfin-EW1X also support remotely configure, monitor with IOTService.

The Elfin-EW1X using highly integrated hardware and software platform, it has been optimized for all kinds of applications in the industrial control, smart grid, personal medical application and remote control that have lower data rates, and transmit or receive data on an infrequent basis.

The Elfin-EW1X integrates all serial to Wi-Fi functionality with 61 x 26 x 17.8mm size.

## 1.2. Device Parameters

Table1. Elfin-EW1X Technical Specifications

Item	Parameters
<b>System Information</b>	
Processor/Frequency	160MHz
Flash/SDRAM	2MB/352KB
Operating System	mbed
<b>Network Protocol</b>	
Network Protocol	IP, TCP, UDP, DHCP, DNS, HTTP Server/Client, ARP, BOOTP, AutoIP, ICMP, Web socket, Telnet, uPNP, NTP, Modbus TCP
Security Protocol	TLS v1.2 AES 128Bit DES3
<b>Wi-Fi Interface</b>	
Standard	802.11 b/g/n
Frequency	2.412GHz-2.484GHz
Network Mode	STA/AP/STA+AP
Security	WEP/WPAPSK/WPA2PSK
Encryption	WEP64/WEP128/TKIP/ AES
Tx Power	802.11b: +18dBm (Max.) 802.11g: +16dBm (Max.) 802.11n: +15dBm (Max.)
Rx Sensitive	802.11b: -89dBm 802.11g: -81dBm 802.11n: -71dBm
Antenna	Internal:PCB
<b>Serial Port</b>	
Port Number	EW10:1 RS232 EW11:1 RS485
Data Bits	7,8

Stop Bit	1,2
Check Bit	None, Even, Odd
Baud Rate	TTL: 300 bps~230400 bps
Flow Control	No Flow Control Software Xon/ Xoff flow control
<b>Software</b>	
Web Pages	Http Web Configuration Customization of HTTP Web Pages
Configuration	Web CLI XML import Telnet IOTService PC Software
<b>Basic Parameter</b>	
Size	61 x 26 x 17.8 mm
Operating Temp.	-40 ~ 85°C
Storage Temp.	-45 ~ 105°C, 5 ~ 95% RH (no condensation)
Input Voltage	Elfin-EW10, Elfin-EW11, Elfin-EW10-0, Elfin-EW11-0: 5~18VDC Elfin-EW10A-0, Elfin-EW11A-0, Elfin-EW10A-0, Elfin-EW11A-0: 5~36VDC
Working Current	~200mA
Power	<700mW

### 1.3. Key Application

The Elfin-EW1X device connects serial device to networks using the TCP/IP protocol:

- Remote equipment monitoring
- Asset tracking and telemetry
- Security Application
- Industrial sensors and controls
- Medical devices
- ATM machines
- Data collection devices
- Universal Power Supply (UPS) management units
- Telecommunications equipment
- Data display devices
- Handheld instruments
- Modems
- Time/attendance clocks and terminals

## 2. HARDWARE INTRODUCTION

The Elfin-EW1X unit is a complete solution for serial port device connecting to network. This powerful device supports a reliable and proven operating system stored in flash memory, an embedded web server, a full TCP/IP protocol stack, and standards-based (AES) encryption.

Elfin-EW1X serial server for data transfer via Wi-Fi, which makes the data transformation very simple.



Figure 1. Elfin-EW10 Appearance



Figure 2. Elfin-EW11 Appearance

### 2.1. Elfin-EW10 Pins Definition

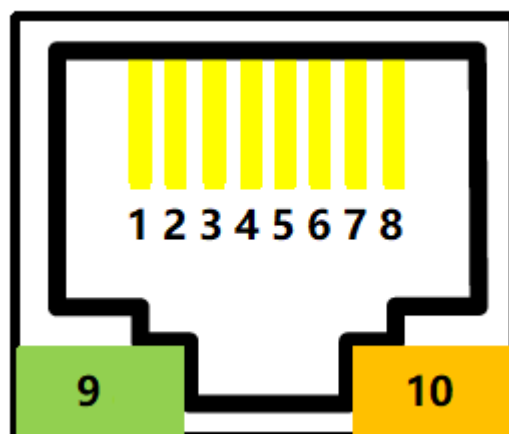



Figure 3. Elfin-EW10 RJ45 Interface Pin

Table2. Elfin-EW10 Interface Definition

Pin	Description	Net Name	Signal Type	Comment
1	GPIO	GPIO	IO	Reserved
2	GPIO	GPIO	IO	Reserved
3	GPIO	GPIO	IO	Reserved
4	Restore to Factory	nReload	I	<b>Default pulled-high.</b> <b>Detailed functions see &lt;Notes&gt;</b>
5	UART1_TXD	UART1_TXD	O	RS232 Voltage
6	UART1_RXD	UART1_RXD	I	RS232 Voltage
7	Power VCC	VCC	Power	5~18VDC
8	Power GND	GND	Power	
9	<b>Green LED</b> Net Status	Net	O	Boot On: Power is OK. 0.1s Off -> 0.1s On: SmartLink Config Mode 0.3s Off -> 3s On: STA mode connect to router or AP mode being connected by other STA. 0.3s Off ->0.3s On: No Wi-Fi Connection
10	<b>Amber LED</b> Data Transfer	Active	O	Off: No data transfer 0.3s Off -> 0.9s On: UART TX Output 0.3s Off -> 0.3s On: UART RX Receive On: UART bidirection.

## 2.2. Elfin-EW11 Pins Definition

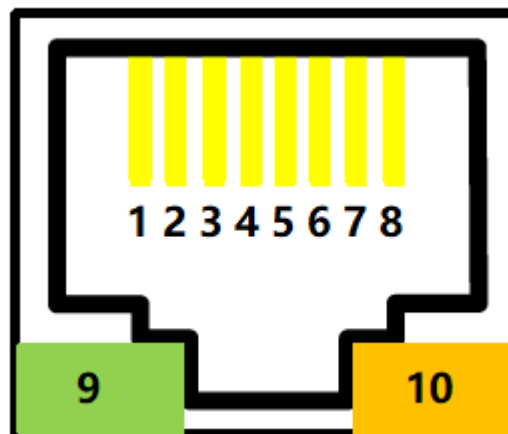

Figure 4. Elfin-EW11 RJ45 Interface Pin

Table3. Elfin-EW11 Interface Definition

Pin	Description	Net Name	Signal Type	Comment
1	Debug TX	UART2_TXD	O	TTL voltage

Pin	Description	Net Name	Signal Type	Comment
2	Debug RX	UART2_RXD	I	TTL voltage
3	GPIO	GPIO	IO	Reserved
4	Restore to Factory	nReload	I	<b>Default pulled-high.</b> <b>Detailed functions see &lt;Notes&gt;</b>
5	UART1_TXD	RS485_A+	IO	RS485 A+
6	UART1_RXD	RS485_B-	IO	RS485 B-
7	Power VCC	VCC	Power	5~18VDC
8	Power GND	GND	Power	
9	<b>Green LED</b> Net Status	Net	O	Boot On: Power is OK. 0.1s Off -> 0.1s On: SmartLink Config Mode 0.3s Off -> 3s On: STA mode connect to router or AP mode being connected by other STA. 0.3s Off ->0.3s On: No Wi-Fi Connection
10	<b>Amber LED</b> Data Transfer	Active	O	Off: No data transfer 0.3s Off -> 0.9s On: UART TX Output 0.3s Off -> 0.3s On: UART RX Receive On: UART bidirection.

**<Notes>**

**I — Input; O — Output; I/O: Digital I/O; Power—Power Supply**

**nReload Pin (Button) function:**

1. After module is powered up, short press this button (0.2< “Low” <1.5s) and loose to make the module go into “SmartLink“ config mode, waiting for APP to set password and other information. (See Appendix to download SmartLink APP)
2. After module is powered up, long press this button (“Low” > 4s) and loose to make the module recover to factory setting.

**UART1 Debug :**

1. Is used for debug log or firmware program. Baud Rate is 921600.

**2.3. RS232 Interface**

Device RS232 does not support hardware flow control. The physical voltage is about  $\pm 7V$ .

**2.4. RS485 Interface**

RS485 use two wire links, A(DATA+), B(DATA-). Connect A(+) to A(+), B(-) to B(-) for communication. Suggest to connect GND together when interference is very severe.

The RS485 interface support maximum 32 485 device, device. The cable maximum length is 1200 meters. Need to add 120Ohm terminal resistor for over 300 meters.

## 2.5. Mechanical Size

The dimensions of Elfin-EW1X are defined as following picture (mm):

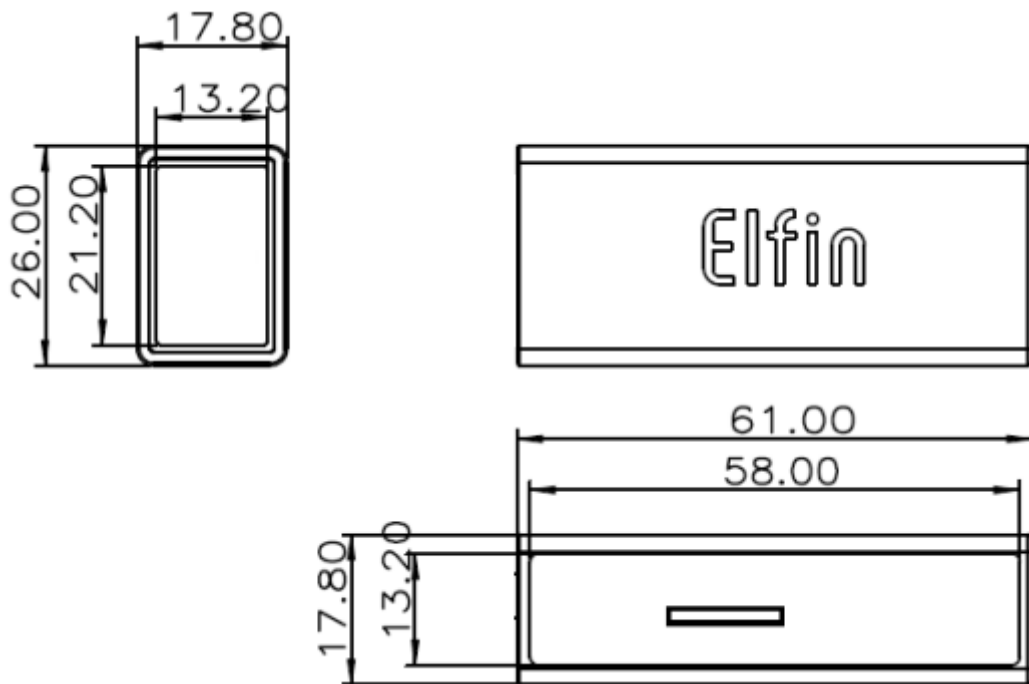

Figure 5. Elfin-EW1X Mechanical Dimension

## 2.6. RJ45 8PIN Connector



Figure 6. RJ45 8PIN Connector



Figure 7. EW10 +8PIN Connector

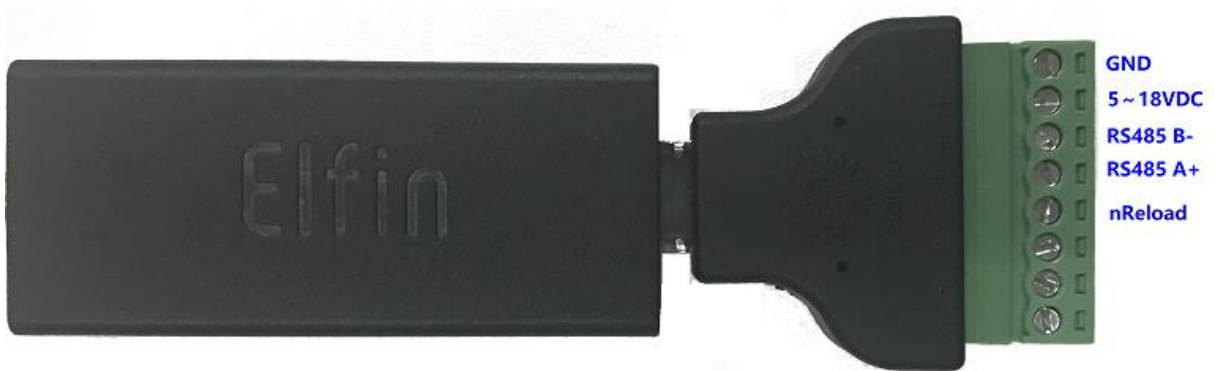

Figure 8. EW11+8PIN Connector

## 2.7. RJ45 4PIN Connector



Figure 9. RJ45 4PIN Connector



Figure 10. EW10 +4PIN Connector



Figure 11. EW11+4PIN Connector

### 2.8. EW10 Interface Conversion Cable



Figure 12. Interface Conversion Cable

May also make cable according to the following picture.

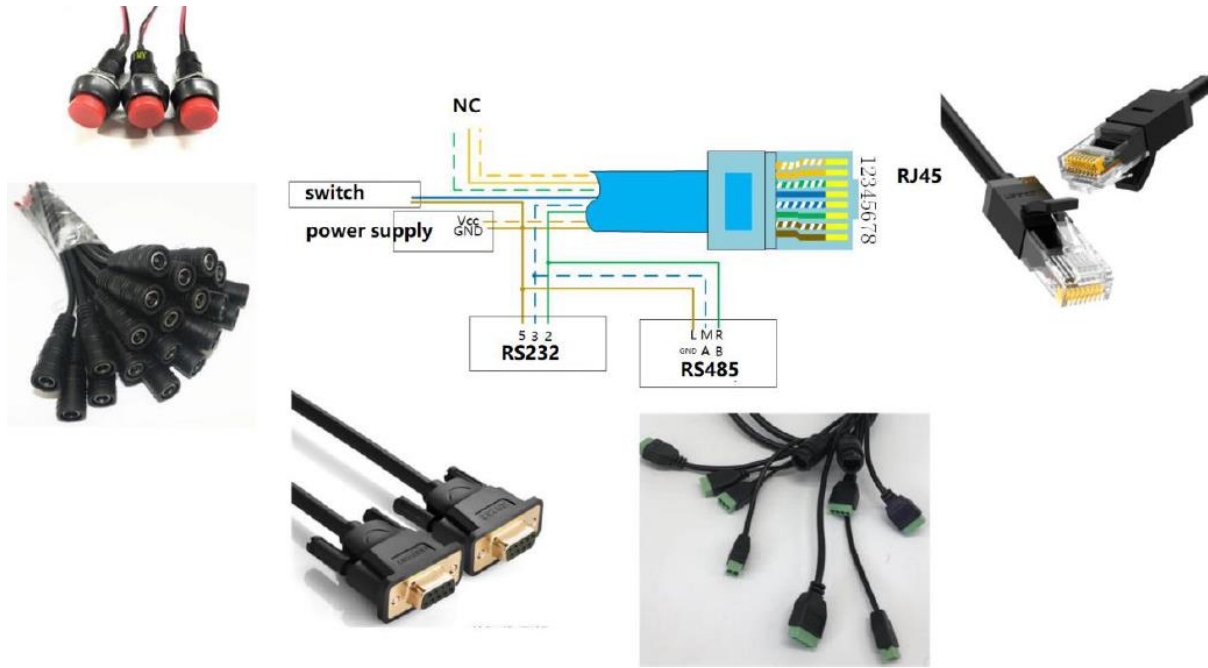

Figure 13. Cable Manufacture Guide

### 2.9. EW11 Interface Conversion Cable



Figure 14. Interface Conversion Cable

### 2.10. Fixed Bracket



Figure 15. Fixed Bracket

### 2.11. Rail Bracket



Figure 16. Rail Bracket

### 2.12. Bracket

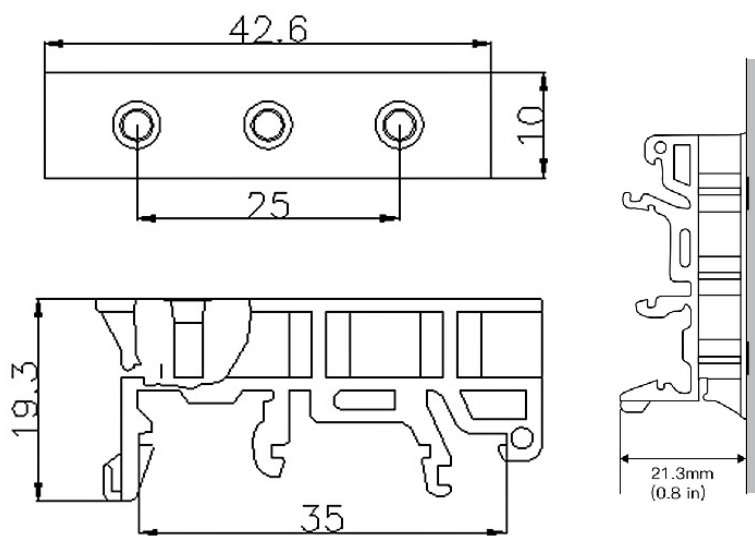

Figure 17. Bracket Size



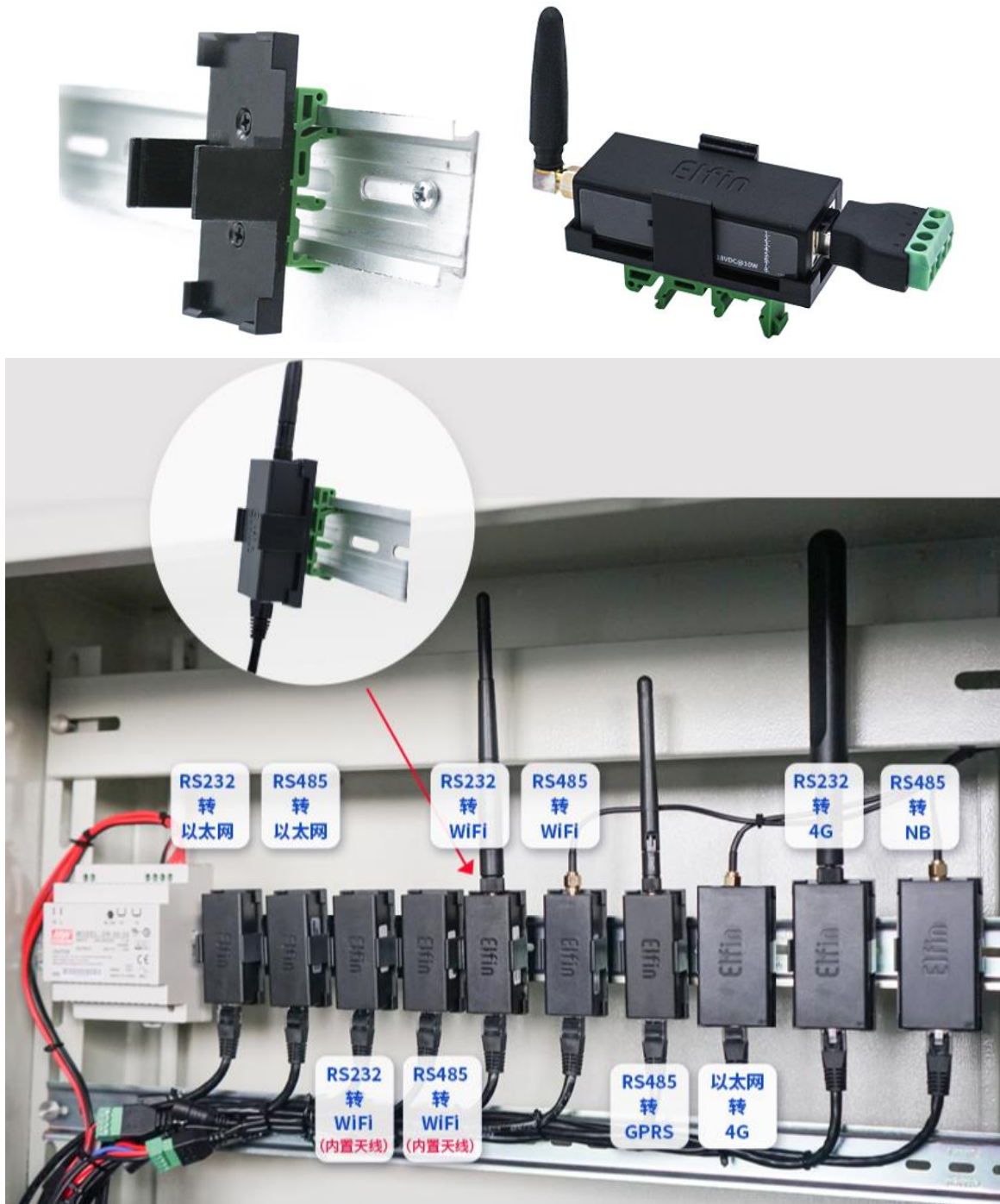

Figure 18. Bracket Install Picture

### 2.13. Product Installation

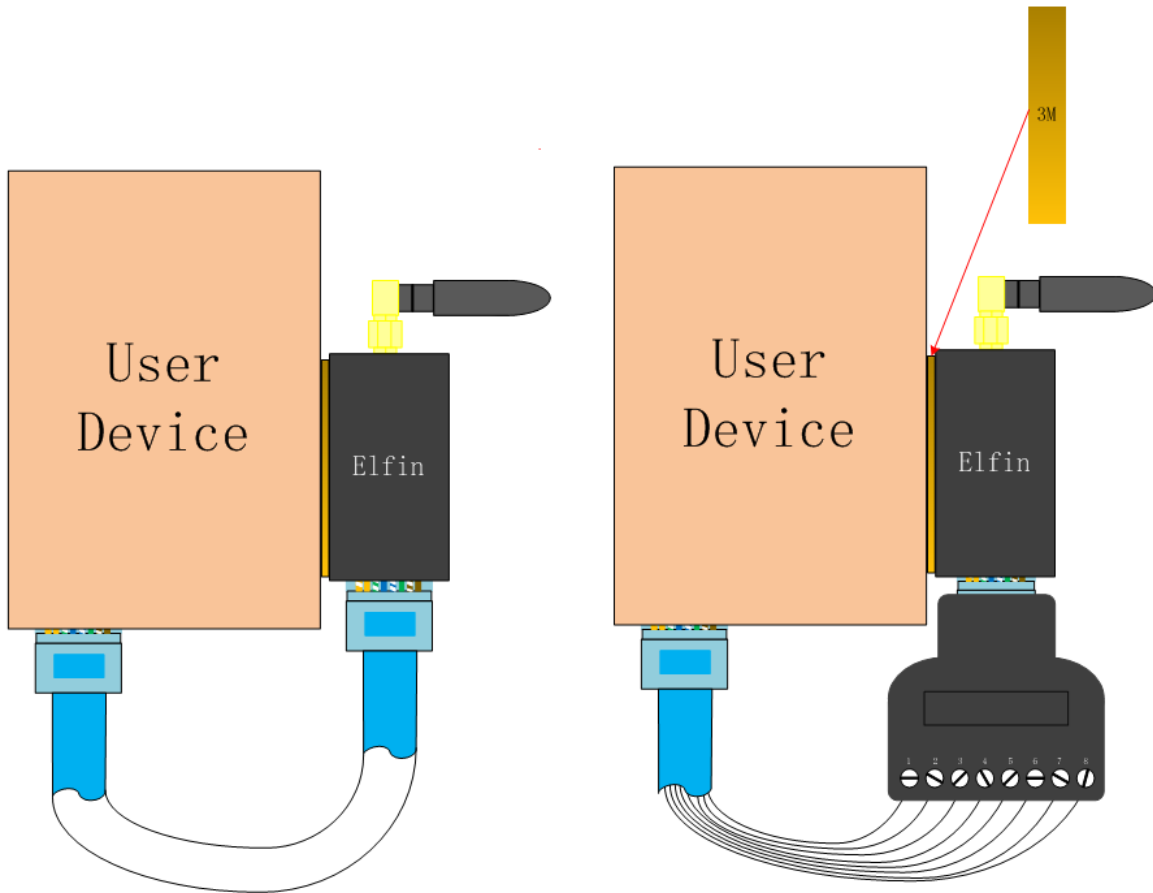

Figure 19. Product Installation

### 2.14. EVK

EVK include one Elfin device, one RJ45 Connector and one screw driver.



Figure 20. EVK Package

## 2.15. Order Information

Base on customer detailed requirement, Elfin-EW1X provide different configuration version, Details as below:

Function Model	Power Input	Type	Antenna	UART	UART Number
Elfin-EW10	5~18VDC	Wi-Fi	Internal	RS232	1
Elfin-EW11	5~18VDC	Wi-Fi	Internal	RS485	1
Elfin-EW10-0	5~18VDC	Wi-Fi	External SMA	RS232	1
Elfin-EW11-0	5~18VDC	Wi-Fi	External SMA	RS485	1
Elfin-EW10A	5~36VDC	Wi-Fi	Internal	RS232	1
Elfin-EW11A	5~36VDC	Wi-Fi	Internal	RS485	1
Elfin-EW10A-0	5~36VDC	Wi-Fi	External SMA	RS232	1
Elfin-EW11A-0	5~36VDC	Wi-Fi	External SMA	RS485	1

Figure 21. Elfin-EW1X Product Order Information

## 3. NETWORK STRUCTURE

### 3.1. Wireless Network

Product can be set as a wireless STA and AP as well. And logically, it supports two wireless interfaces, one is used as STA and the other is AP. Other STA devices can join into the wireless network through AP interface. So the it can provide flexible networking method and network topology.

<Introductions>

AP: Wireless access point which is the central joint. Usually, wireless router is a AP, other STA devices can connect with AP to join the network.

STA: Wireless station which is terminal of a wireless network. Such as laptop and pad etc.

#### 3.1.1. AP Network

HF2211 can construct a wireless network as AP. All the STA devices will consider the AP as the centre of the wireless network. The mutual communication can be transponded by AP, shown as follow:



Figure 22. General AP Network

### 3.1.2. STA Wireless Network

Take the following picture as example. When router works in AP mode, HF2211 connects to the user's devices by RS232/RS485 interface. In this topology, the whole wireless network can be easily stretched.

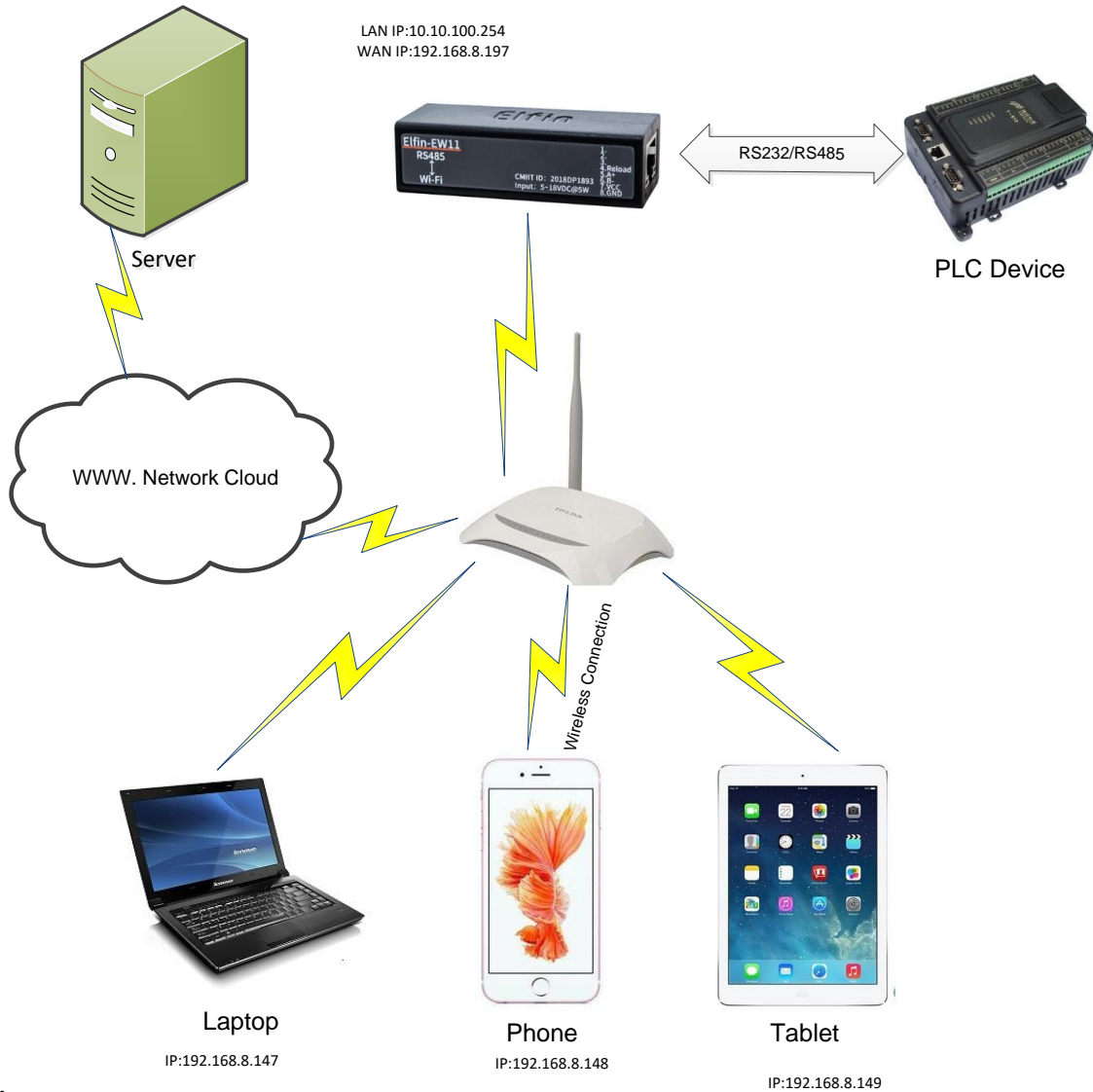

Figure 23. STA Application

### 3.1.3. AP+STA Wireless Network

HF2211 can support AP+STA method. It can support AP and STA interface at the same time. Shown as follow:



Figure 24. AP+STA Wireless Network

In this picture, open the AP+STA function and the STA interface can be connected to the remote server by the router. Similarly, the AP interface can also be used. Phone/PAD can be connected to the AP interface and to control the serial devices or set itself.

Through AP+STA function, it is convenient to use Phone/PAD to monitor the user's devices and not change its original settings.

**Notes that:**

**When the AP+STA function is opened, the STA interface needs to connect to other router. Otherwise, STA interface will endlessly scan the router information nearby. When it is scanning, it will bring bad effects to the AP interface, like losing data etc.**

**AP and STA parts must set to the different sub-network for the product working as APSTA mode.**

**Does not support Wi-Fi repeater function that means device works in AP+STA(STA connects to router), PC connects to device AP, but can not access to internet (If need this router function, use HF2211/HF2221)**

### 3.1.4. IOTService Software

Open the IOTService after connect to the AP hotspot generated by HF2211 or connect to Product Ethernet port to PC, then configure the parameter.

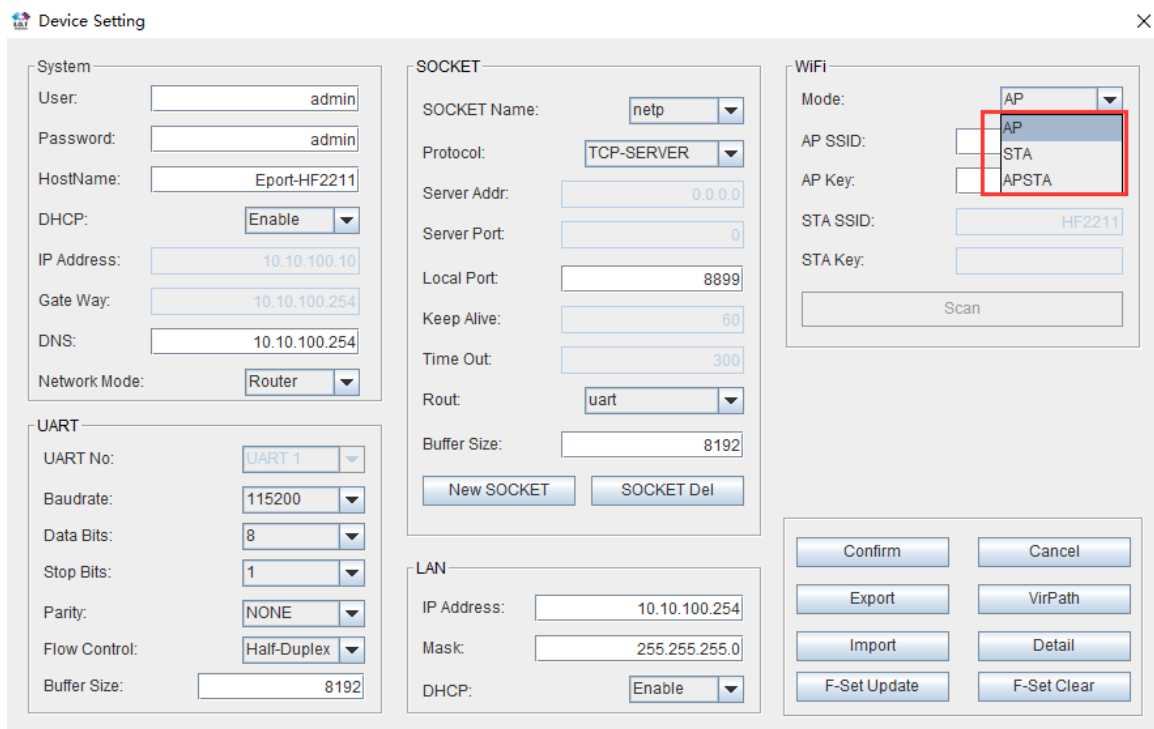

Figure 25. Configure Wi-Fi Parameter

Scan

Select	Channel	SSID	MAC Address	RSSI	Has Key
<input type="radio"/>	11	Sam401	D4:EE:07:2D:14:1E	100	Yes
<input type="radio"/>	10	ChinaNet-yRMx	38:E3:C5:A2:87:D5	100	Yes
<input type="radio"/>	11	UPGRADE-AP	20:DC:E6:48:35:9E	39	Yes
<input type="radio"/>	6	xiaoheizi	B0:95:8E:06:CB:16	29	Yes
<input type="radio"/>	11	Caoyu	78:96:82:A2:C6:A2	0	Yes
<input type="radio"/>	0	Caoyu		0	Yes

Figure 26. STA Scan Parameter

### 3.1.5. Webpage Configuration

Use PC to connect with HF2211 through its AP hotspot or Ethernet connection. Input the default IP(10.10.100.254, default username and password: admin/admin) to login the webpage to configure the parameter.

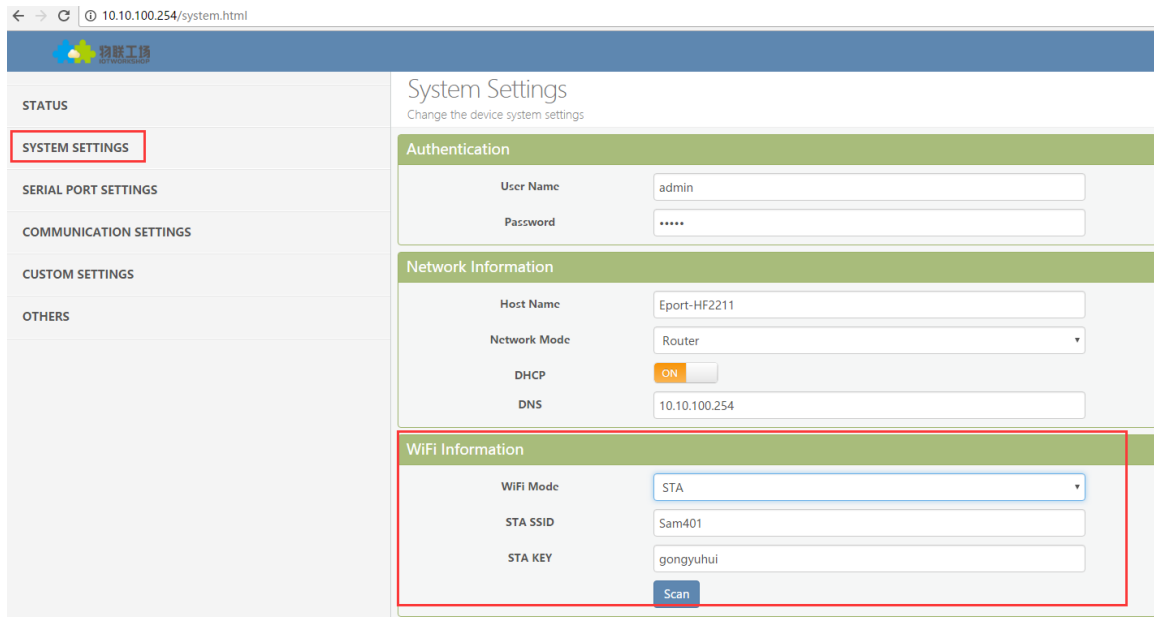

Figure 27. Configure the Wi-Fi Parameter

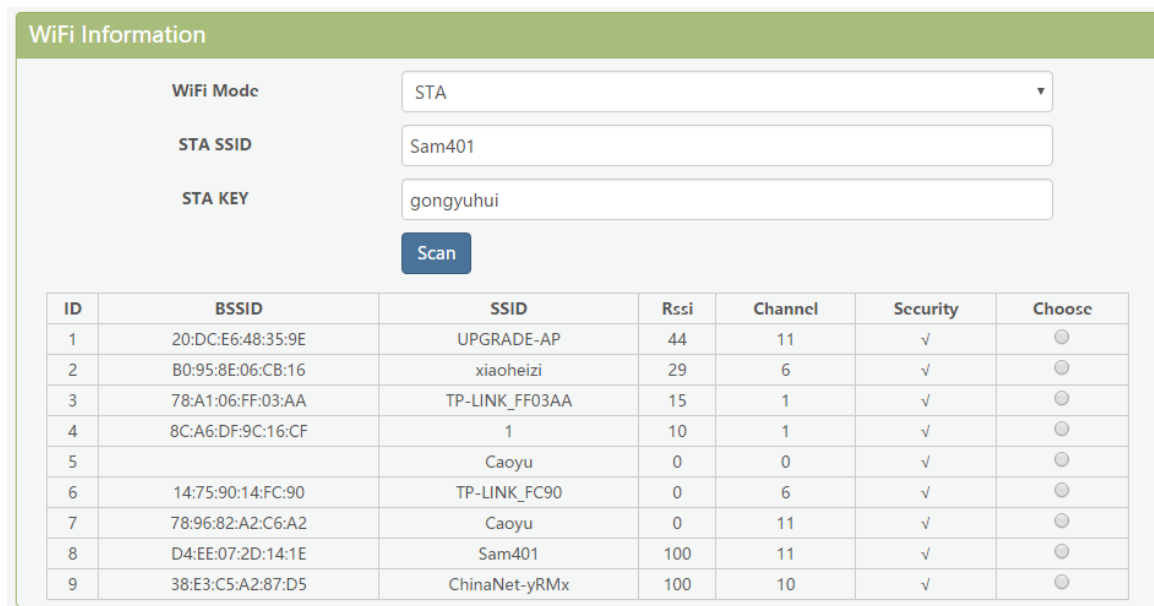

Figure 28. STA Scan



## 4. FUNCTION DESCRIPTION

Refer to “IOT\_Device\_Series\_Software\_Funtion” document for more detailed function.

## APPENDIX A: CONTACT INFORMATION

---

**Address:** Room 1002,Building 1,No.3000,Longdong Avenue,Pudong New Area,Shanghai,China,201203

**Web:** [www.iotworkshop.com](http://www.iotworkshop.com) or [www.hi-flying.com](http://www.hi-flying.com)

**Contact:**

Sales: [sales@iotworkshop.com](mailto:sales@iotworkshop.com)

Support: [support@iotworkshop.com](mailto:support@iotworkshop.com)

Service: [service@iotworkshop.com](mailto:service@iotworkshop.com)

Business: [business@iotworkshop.com](mailto:business@iotworkshop.com)

---

For more information about IOTworkshop modules, applications, and solutions, please visit our web site [www.iotworkshop.com](http://www.iotworkshop.com)

**<END OF DOCUMENT>**